

SMS Storage Groups

Origins, Mysteries, Management

Steve Pryor
steve@dtssoftware.com
1.919.833.8426 x162



The Dataset Allocation Process

```
// DSN=, LRECL=, BLKSIZE=,RECFM=,  
    type of dataset (PS, PO, VSAM..)  
// SPACE=(CYL,(10,1),RLSE), STORCLAS=, et. al.
```

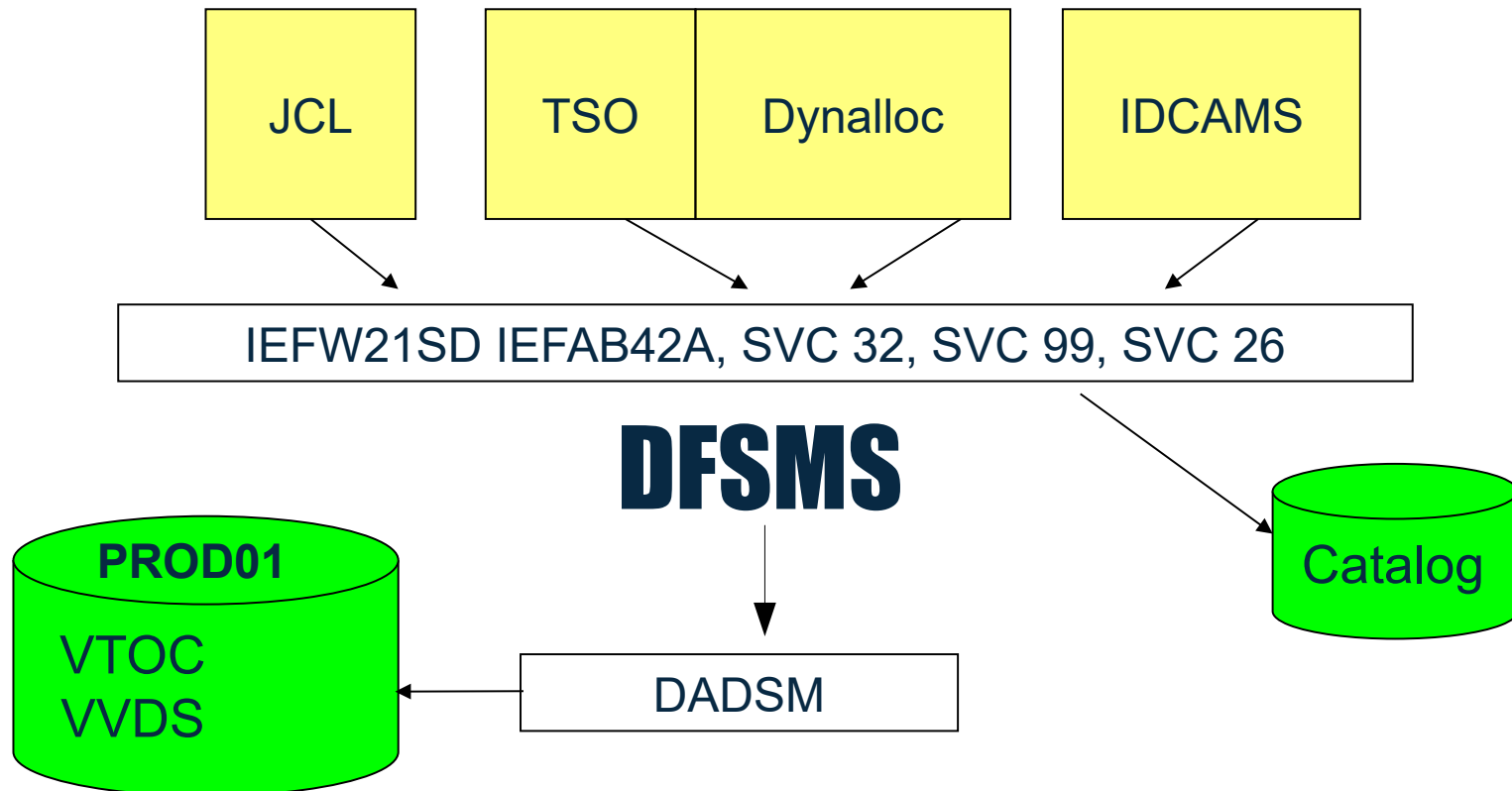

Classifying Datasets

The SMS Constructs

Space, RETPD, vol count, DSNTYPE, encr keys...

Performance & Availability
Striped? Flashcopy?
Guaranteed Space?
PAV, Multitier SG?

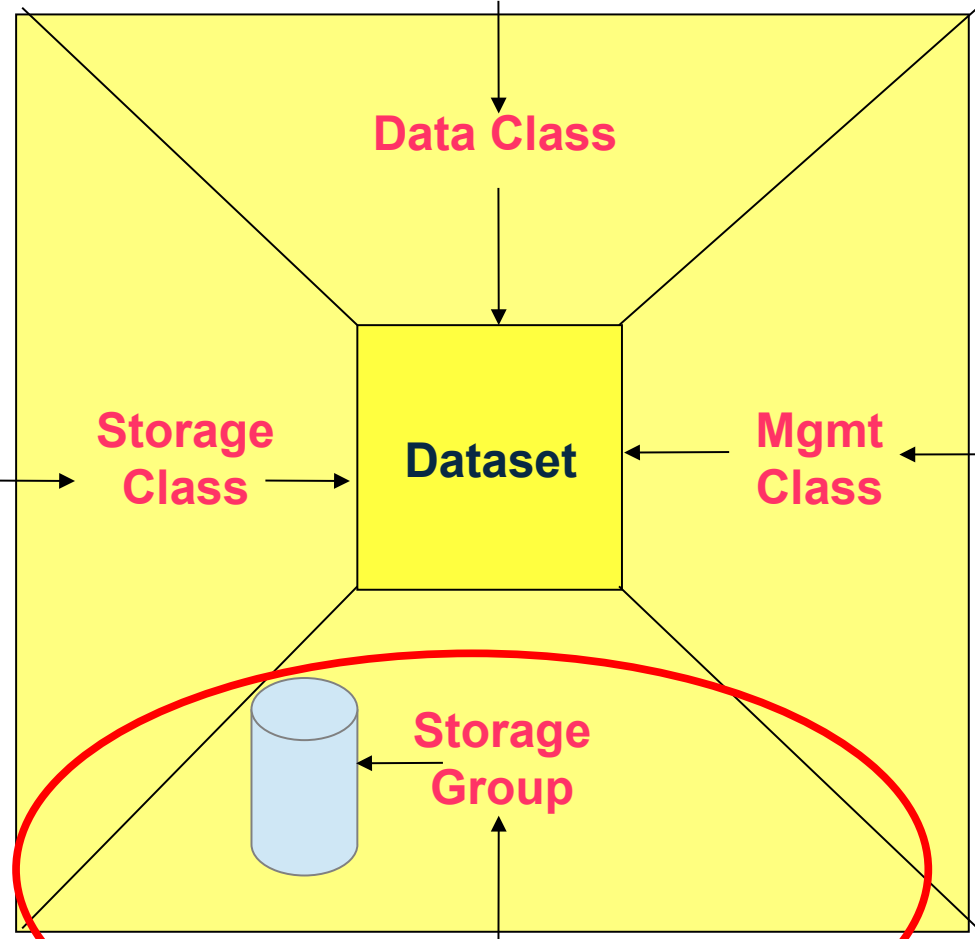

What backups are needed?
When should it migrate?
How many gens?

What **volume(s)** should be chosen?

Storage Group

- **Cannot** specified in JCL or IDCAMS
- **Not stored** in NVR / VVR and BCS cells

- Datasets are SMS-managed if assigned a SC
 - *If a STORCLAS is assigned, STORGRP will be assigned*

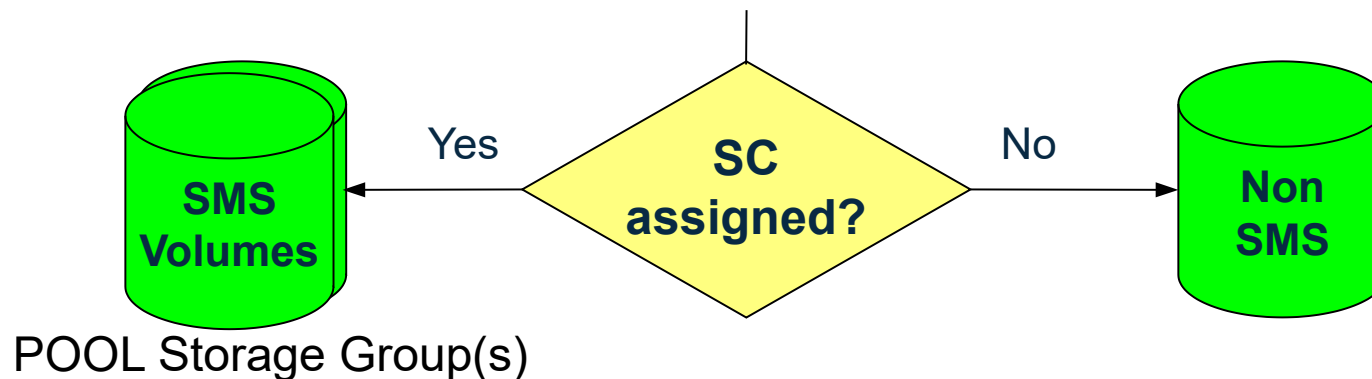

ACS Routines Assign Constructs

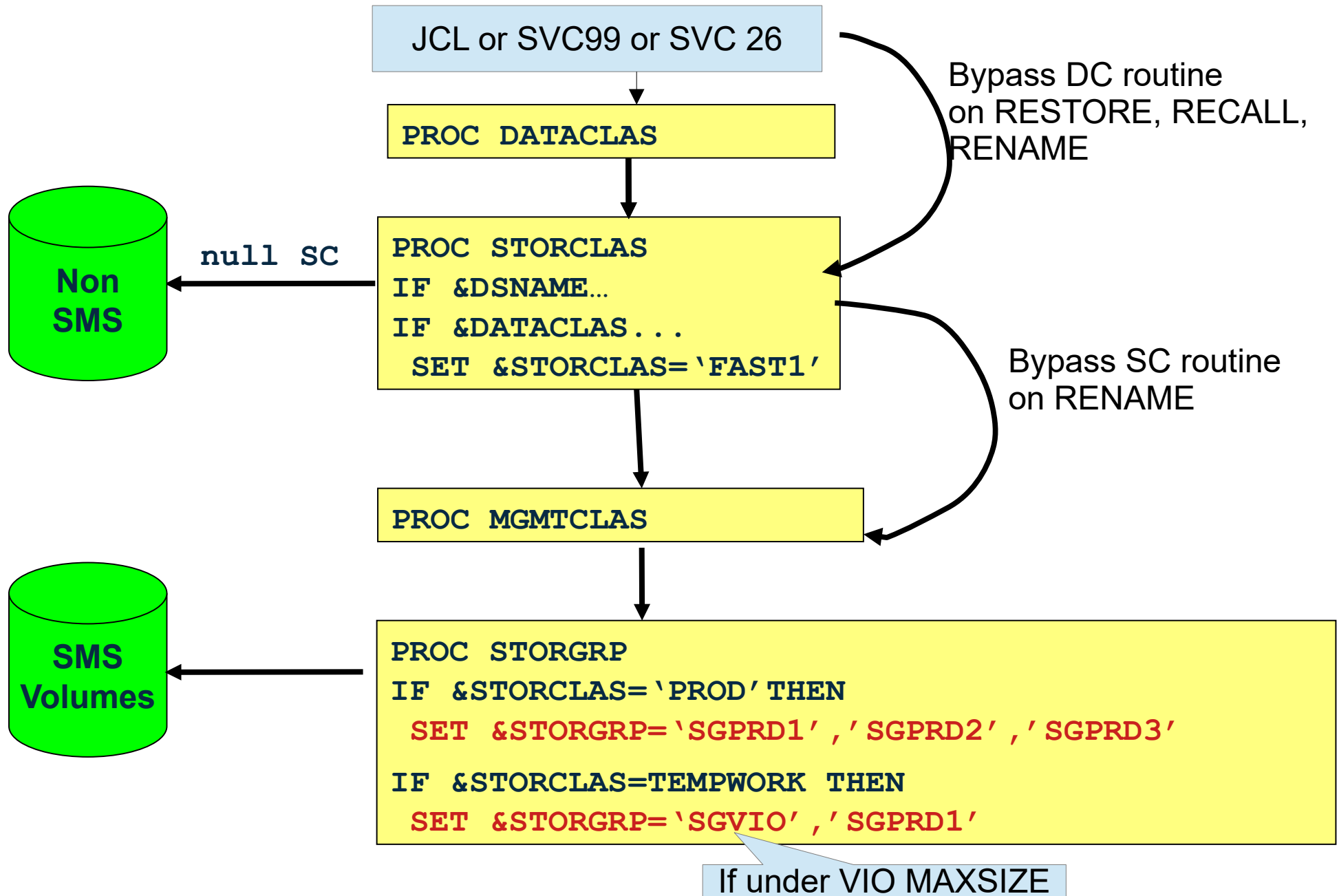

Types of Storage Groups

- VIO – temp DSNs backed by paging subsys
- POOL – SMS-managed disk volumes
- TAPE – SMS-managed tape volumes
- DUMMY – Nonexistent disk volumes
- OBJECT – object directory/libraries
- OBJECT BACKUP – object tape backup
- COPY POOL BACKUP – FRBACKUP targets

Display SMS SG/Volume Status

- ISMF Option 2 (1=DASD, 2=Tape)
- Console Commands
 - D SMS,SG(sgname),LISTVOL
 - Includes utilization level
 - D SMS,VOL(volser)

POOL Storage Group Attributes

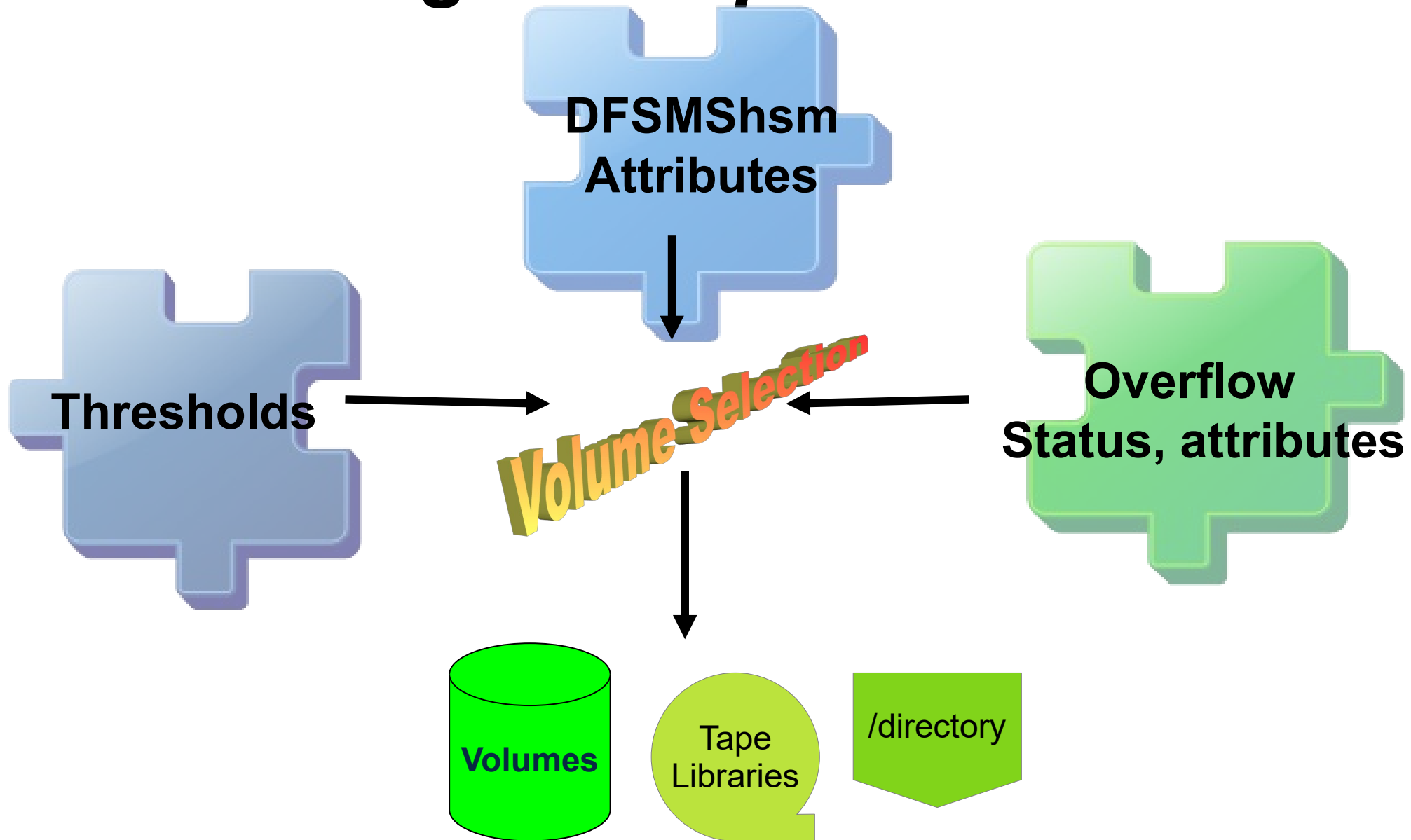

POOL Volume Selection

- Primary List
 - ENABLEd, online,
 - Meets IARS, Accessibility, Availability, GS, PAV, etc
 - Enough vols in SG for volume count
 - Allocation **will not exceed** vol threshold
- *Secondary List*
 - Can meet allocation but **will exceed** threshold
- Tertiary List
 - Not enough volumes in SG for volume count
- Volumes are ordered by preference weight based on SC attributes

Volume Selection Attributes

- Multi-Tiered Storage Group

- Honor the order of SG assignment
- Storage Group ACS routines assigns >1 SG, e.g:
`SET &STORGRP = 'STG1' , 'STG2' , 'STG3'`
- Volumes in STG1 selected first, STG2, second, etc.
 - if below SG free-space threshold



- FAST_VOLSEL(ON/OFF)

- When 100 DADSM rejects for insuff space, use SMS stats for volume space
 - reduce candidate volume count, retries, CPU overhead
 - always used for striping

POOL Storage Groups

DFSMShsm Attributes

- Autobackup
- Automigrate → Migration Functions
 - Primary space management
 - Interval Migration
 - On-demand Migration
- Autodump
- Migrate Sys/Sysgroup Name
 - Blank = any system
 - Specified host
 - System group (host not defined in configuration)
- Dump Class
- Guaranteed Backup Frequency
 - Minimum interval between backups, default = use MC
- Processing Priority
 - order of processing during Space Management, default=50

POOL Storage Groups

Attribute Types

- **OVERFLOW Storage Groups**
 - Volumes automatically placed in secondary list for **allocation**
 - Used when volumes in non-Overflow SG are over threshold
 - Preferred over QUIESCED volumes
- **EXTEND Storage Groups**
 - Used to extend **existing** datasets from primary storage group
 - Can be chained or specified in more than one primary SG
 - Need not be specified in SET &STORGRP=
- **COPY POOL Backup Storage Groups**
 - Volumes for FRBACKUP

POOL Storage Groups Thresholds

- Allocation / Migration Thresholds
 - **Allocate** to other volumes when utilization > HI, issue ENF72
 - **Migrate** if over high threshold, stop when under low threshold
 - Space Alert Thresholds
 - Message IGD400I issued at 10% intervals from threshold
- IGD400I TOTAL SPACE ALERT ON STORAGE GROUP(sgname) CURRENT USAGE(xx%),ALERT THRESHOLD(yy%)
- BreakpointValue – size to use cylinder-managed space on EAV

VIO Storage Group Attributes

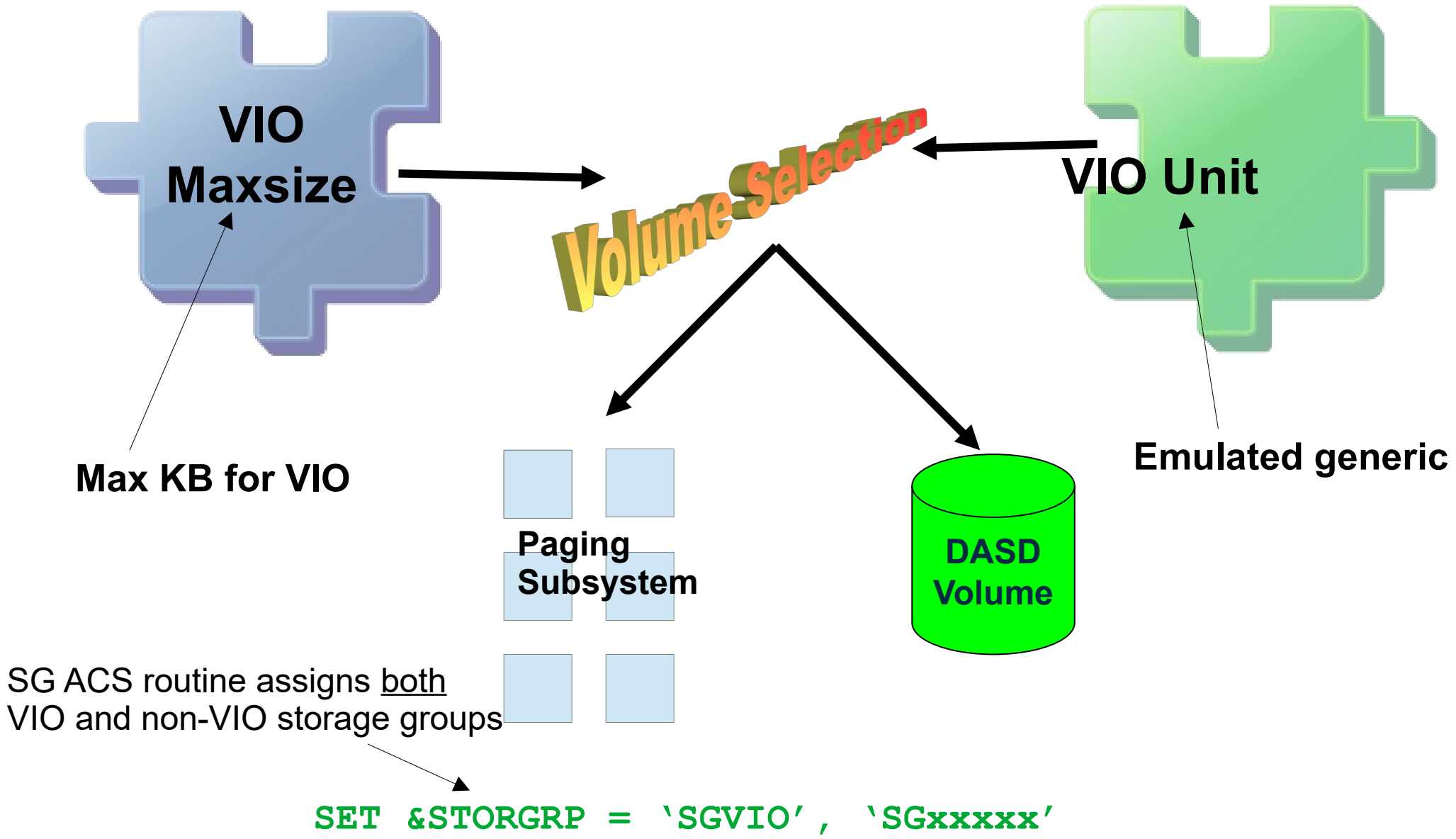

DUMMY Storage Groups

- For *SMS-managed* datasets
- Volumes that *do not exist* in system
 - Volumes must be specified in SG volume definition
- Prevent catalog errors for vols explicitly referenced in JCL or IDCAMS but now SMS

```
//DD1 DD DSN=SJP.XXX.DS1,DISP=SHR,VOL=SER=XXX001
```

TAPE Storage Groups

- Library Name (1-8)
 - Tape library defined in SCDS
 - via ISMF option 10.3 or IDCAMS DEFINE LIBRARYENTRY
 - Libraries and volumes also defined in Tape Mgmt System
- Library Definition (ISMF 10.3)
 - Library ID
 - Default Data Class, Use Attribute
 - Eject Default
 - Scratch message thresholds

OBJECT and OBJECT BACKUP

OAM Storage Hierarchy

- Disk – sublevel 1 (DB2 tables)
- Disk – sublevel 2 (NFS or zFS filesystem)
- Tape sublevels 1 or 2
 - Tape UNIT name defined in CBROAMxx
- Optical

COPY POOL BACKUP Storgrp

- Target vols for FRBACKUP requests
 - Same size as source volume
 - Not in FLASHCOPY or XRC/PPRC pair
- Volumes cannot be used for ordinary SMS

Volume Selection Tracing via SETSMS or IGDSMSxx

- TYPE (ERROR/ALL)
 - TYPE(ERROR(xxxx), ALL(yyyy))
- VOLSELMSG
 - ON/OFF
 - 0 / nnnnn / ALL
- ASID / DSNAME / JOBNAME / STEPNAME

SETSMS VOLSELMSG(ON,ALL) TYPE(ALL) JOBNAME(SJPX)

Related SYS1.PARMLIB Members

- IGDSMSxx – SMS Defaults
 - BREAKPOINTVALUE (0-65520)
 - VSAM_HYPERLINK (YES/NO)
 - FAST_VOLSEL (ON/OFF)
 - USEEAV (YES/NO)
 - INTERVAL (15)
 - VOLSELMSG (ON/OFF or 0/nvols/ALL
 - Requires TRACE and ASID/JOBNAME/STEPNAME/DSN
- CBROAMxx – OAM Defaults
 - SETOAM

ISMF Test Facility / DTS SMSDEBUG Enhanced Testing

- Test cases are PDS members
- **You** must insure that appropriate ACS variables are set
- Tests only the ACS routines – does **not** test volume selection

ISMF Test (7.4.3)

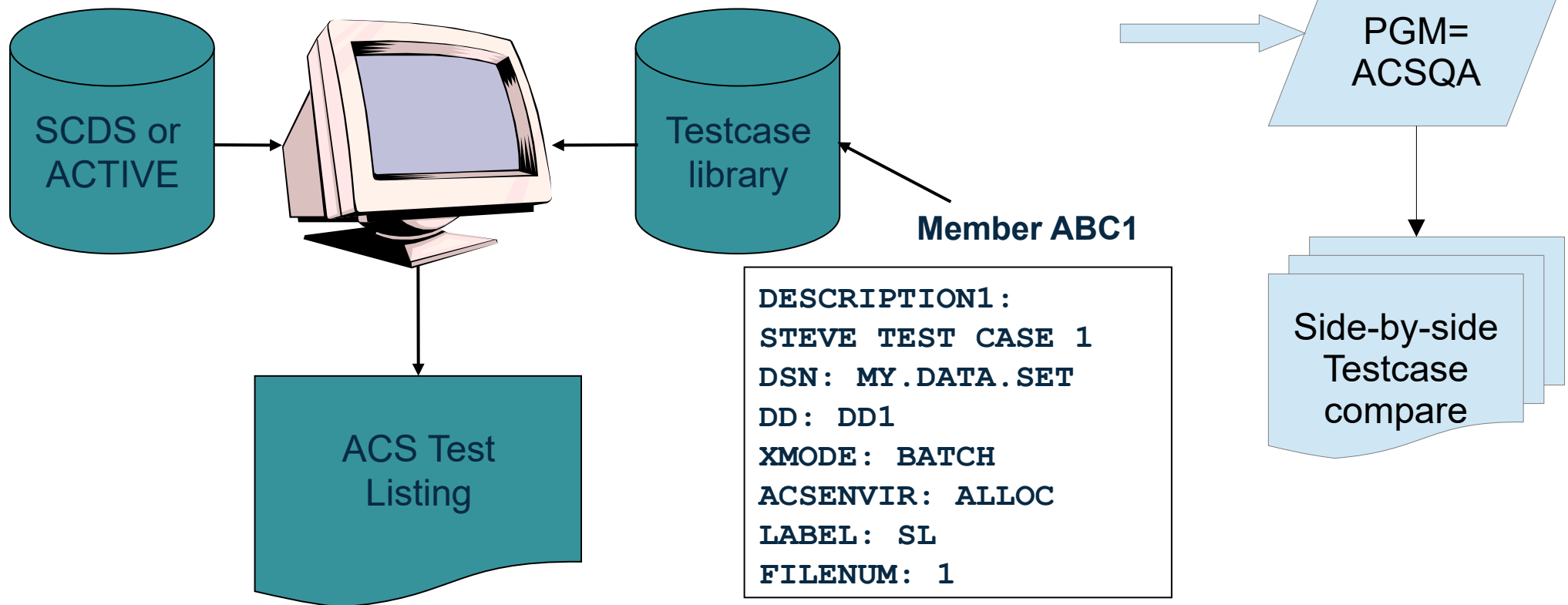

Documentation

- DFSMSdfp Storage Administration SC23-6860
- MVS Init and Tuning Reference SA23-1380
- Volume Selection Informational APARs
 - II08004, II08987

SMSAUDIT & SMSDEBUG

Configuration Compare, ACS Trace, & more

COMPARE CDS1=cdsname / ACTIVE,
CDS2=cdsname / ACTIVE,
NAME1=constructname,
NAME2=constructname,
CONSTRUCTS=(ALL,DC,SC,MC,SG,AG,BC,LD,CP,CL,ACS),
SHOWBCD(YES/NO),
SMFRID=nnn

Constructs Compared:

DATACLAS,	AGGREGATE GROUP,
STORCLAS,	BASE CONFIGURATION,
MGMTCLAS,	TAPE LIBRARY DEFINITION,
STORGRP ,	COPY POOL,
ACS HEADER,	CLOUD

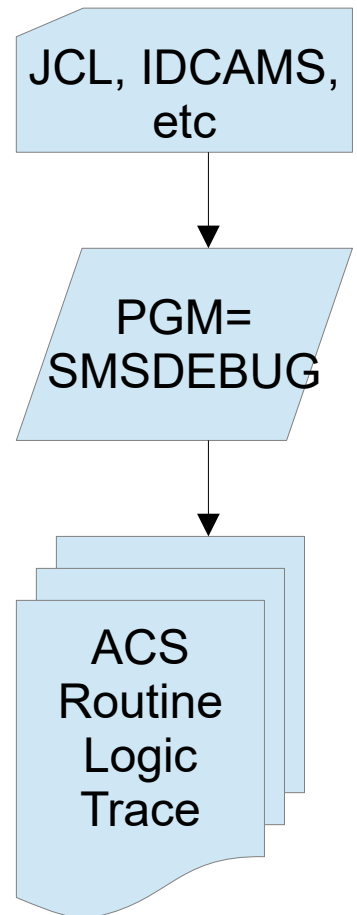
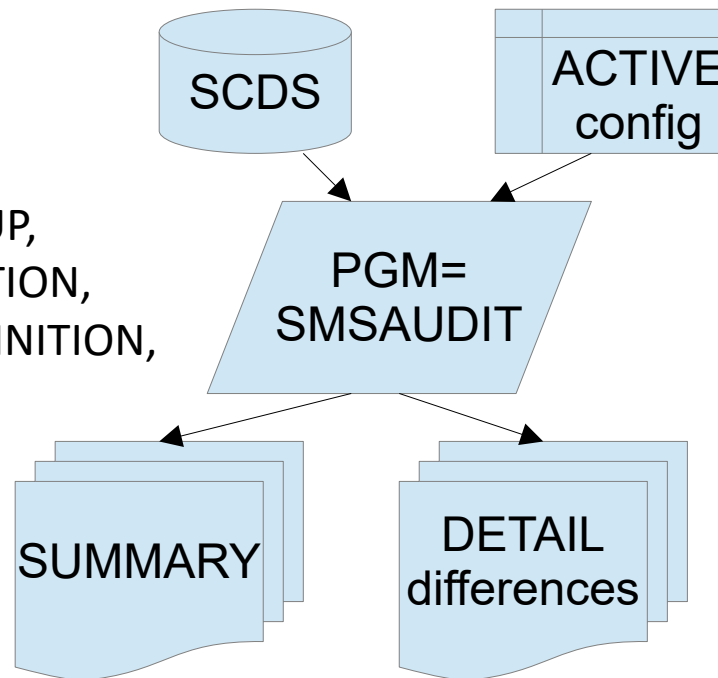

Q and A